

NEW PRODUCT
Ullrich Mesh
Stainless Steel
Security Mesh

No.1 for Safety!



***Designed to protect,
built to last!***

100% NEW ZEALAND OWNED AND OPERATED

PHONE - 0800 500 338 • www.ullrich.co.nz



SECURITY DOORS AND WINDOWS

The Ullrich Security Doors and Window System is designed for application to domestic and commercial buildings to provide an extra barrier against unwanted intrusion, trespass, burglary and home invasion, while allowing unrestricted airflow and vision outdoors.

The system comprises a complete range of extrusions, fittings and accessories ready for custom-fitting to individual specifications and design requirements.

The finished installation is lightweight for ease of use, yet sturdy and secure. Anodised or powder coated in a range of colours provides an attractive, fashionable finish.

Aluminium-alloy manufacturing materials are specially selected for extra durability, toughness and tamper resistance. Heavy duty 7mm Diamond Pattern grille panels exceed the sheer load test and specification requirements of ANZS 2803 and are suitable for inclusion in door framing manufactured and tested to this standard.

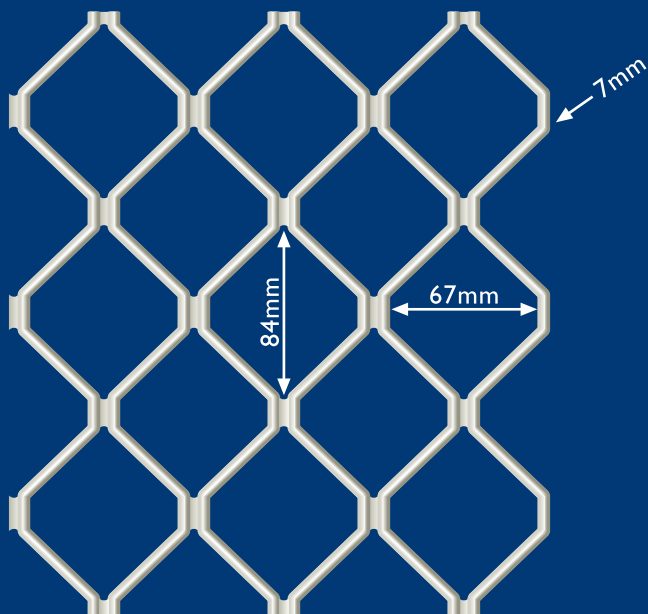

SECURITY MESH (AS2803) '007'

Panel Sizes

2000 x 750 x 7mm
4000 x 750 x 7mm
2000 x 920 x 7mm
4000 x 920 x 7mm
2000 x 1250 x 7mm
4000 x 1250 x 7mm

Available in:

Mill Finish
Silver Anodised
Bronze Anodised
White Powder Coated

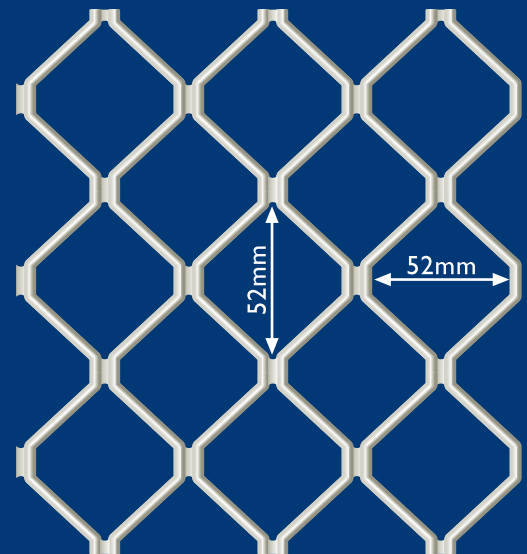

SECURITY MESH (AS2803) '009'

Panel Sizes

2000 x 1160 x 9mm

Available in:

Mill Finish only

ULLRICH INSECT MESH: PRODUCT INFORMATION

COMMERCIAL APPLICATIONS

For doors, windows and partitions in workplaces, storage areas and public buildings, where intrusion of insects is detrimental to comfort and hygiene and where natural airflow is desirable:

Kitchens and food preparation areas
 Garden restaurants, patio bars and cafés
 Hotel and motel dining and accommodation rooms
 Factory cafeterias
 Hospitals and medical facilities
 Food processing plants and storage areas
 Food retail outlets
 Roll curtains for tent manufacturing (fibreglass mesh)

DOMESTIC APPLICATIONS

All dwelling apertures or partitions where intrusion of insects is detrimental to living comfort and hygiene, and where natural airflow is desirable:

Main entrances
 Kitchens
 Dining rooms
 Living rooms and bedrooms
 Breeze-ways
 Conservatories
 Summer houses
 Covered decks and patios
 Pergola walls



MATERIALS

Aluminium

COLOURS

Silver treated
 Black painted

ROLL WIDTHS

610 mm
 710 mm
 760 mm
 810 mm
 910 mm
 1070 mm
 1220 mm
 1520 mm
 1830 mm

MESH SIZES

18 x 14 x 0.009"
 18 x 16 x 0.009"
 18 x 16 x 0.10"

Fibreglass

Black
 Grey

610 mm
 710 mm
 760 mm
 810 mm
 910 mm
 1070 mm
 1220 mm
 1520 mm
 1830 mm

18 x 14 x 0.009"
 18 x 16 x 0.009"
 18 x 16 x 0.10"

Stainless steel

Natural

910 mm
 1220 mm

18 x 14 x 0.009"
 18 x 16 x 0.009"
 18 x 16 x 0.10"

ROLL LENGTHS

Standard 30-metre rolls, individually wrapped. Other roll lengths may be available on request

EXTRUSION PROFILES (drawings not actual size)

DIE NUMBER



UA 5655
DOOR FRAME
Use Stake 5971 - Orange
kg/m 0.763 P 230



UA 1377 (ALSO AVAILABLE PREPUNCHED FOR LOCK)
DOOR FRAME
Use Stake 1864 - Black
kg/m 0.715 P 240



UA 1738
DOOR FRAME
Use Stake 1864 - Black
kg/m 0.581 P 236



UA 4112
SECURITY DOOR FRAME
Use Stake 1864 - Black
kg/m 0.681 P 233

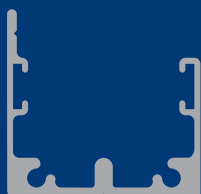

UA 1943
SLIDING DOOR
kg/m 0.467 P 212

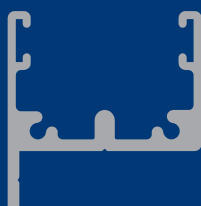

UA 6836
SLIDING DOOR
kg/m 0.477 P 216

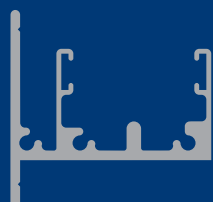

UA 1942
SLIDING DOOR
kg/m 0.773 P 298



UA 3592
SECURITY WINDOW FRAME
Use Stake 1379 - Red
kg/m 0.371 P 146



UA 3929
SECURITY JOINER
kg/m 0.301 P 182

EXTRUSION PROFILES (drawings not actual size)

DIE NUMBER



UA 4598
SECURITY WINDOW FRAME
Use Stake I379 - White
kg/m 0.393 P 118



UA 4599
SECURITY WINDOW JOINER
kg/m 0.357 P 160



UA 1310
WOOLPILE STOP
kg/m 0.147 P 74



UA 1649
SECURITY WINDOW FRAME
Use Stake I379 - Blue
kg/m 0.399 P 197



UA 1374
SECURITY CHANNEL
kg/m 0.151 P 76



UA 1375
SECURITY FIXFRAME
kg/m 0.269 P 142



UA 1376
SECURITY JOINER
kg/m 0.257 P 129



UA 1387
SECURITY WINDOW FRAME
Use Stake I379 - Blue
kg/m 0.282 P 125



UA 6246
WINDOW FRAME
Use Stake FLYFACS3PLGREY
kg/m 0.257 P 105



Wool Pile PR13

UA 1349
DRAUGHT EXCLUDER
Use Woolpile PR13
kg/m 0.123 P 72

EXTRUSION PROFILES (drawings not actual size)**DIE NUMBER**

UA 1386
WINDOW FRAME
Use Stake 1379 - Blue
kg/m 0.237 P 95



UA 1384
TOP CHANNEL
kg/m 0.120 P 74



UA 1383
BOTTOM CHANNEL
kg/m 0.093 P 58



UA 1343
SLIDING DOOR TEE
kg/m 0.173 P 66



UA 1388
FLYDOOR
Use Fly Stake - Plastic
kg/m 0.318 P 109



UA 1389
FLYWINDOW
Use Stake 1513 - Green
kg/m 0.234 P 70



UA 1610
FLYWINDOW
Use Stake 1513 - Green
kg/m 0.235 P 76



UA 1355
BOTTOM CHANNEL
kg/m 0.136 P 67



UA 1609
TOP CHANNEL
kg/m 0.149 P 84



UA 5636
DOOR FRAME
Use Stake 5633 - Yellow
kg/m 0.499 P 142



UA 1385
FRAME
Use Stake 1379 - Blue
kg/m 0.278 P 104

EXTRUSION PROFILES (drawings not actual size)

DIE NUMBER



UA 5637
FLYWINDOW
Use Stake 5635 - 6.0mm thick - Brown
kg/m 0.251 P 96



UA 5638
FLYWINDOW
Use Stake 5635 - 8.5mm thick - Purple
kg/m 0.256 P 103



UA 1054
FLYWINDOW
Use Stake 1513 - Green
kg/m 0.331 P 124



UA 5526
FLYSCREEN SLIDING DOOR CHANNEL
kg/m 0.468 P 200



UA 5699
FLYWINDOW TRACK
kg/m 0.209 P 99



UA 3703
DOOR TRACK (glides available)
kg/m 0.116 P 81



GLIDE/STOP



UA 3614
CHANNEL (for 5632)
kg/m 0.196 P 94



UA 1731
ANGLE
kg/m 0.131 P 64



UA 1133
CHANNEL
kg/m 0.311 P 147



UA 1611
DOOR FRAME
Use Flystake - Plastic
kg/m 0.367 P 110

EXTRUSION PROFILES (drawings not actual size)



DIE NUMBER

UA 3512
RAIL
kg/m 0.611 P 300



UA 1381
RAIL
kg/m 0.730 P 320



UA 1382
RAIL
kg/m 0.361 P 200



UA 5634
RAIL
kg/m 0.568 P 250



UA 1648
DOOR FRAME ADJUSTER
kg/m 0.992 P 219



UA 2985
JAMB EXTENSION
kg/m 1.011 P 492
Option UA9758 (while stocks last)



UA 5632
SECURITY DOOR ADAPTOR
kg/m 1.050 P 318



UA 1647
SECURITY DOOR ADAPTOR
kg/m 1.152 P 326

EXTRUSION PROFILES (drawings not actual size)



DIE NUMBER

FLYSTAKE CORNER - PLASTIC

Fits 1388 & 1611
CODE: FLYSTAKE



UA 5635

CORNER STAKE
8.5mm thick fits 5638 - Purple
6.0mm thick fits 5637 - Brown
kg/m 1.256 P 186

Cut to size

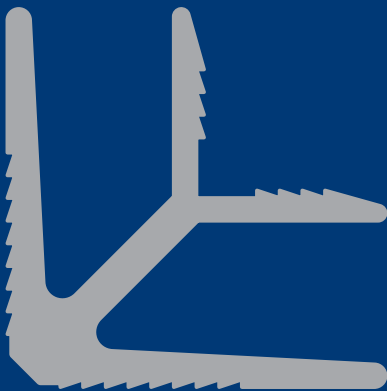

UA 5633

STAKING ANGLE
Fits 5636 - Yellow
kg/m 1.725 P 352

Cut to size



UA 1864

STAKING ANGLE
Fits 1377 & 1738 - Black
kg/m 3.536 P 527

Cut to size

EXTRUSION PROFILES (drawings not actual size)

DIE NUMBER

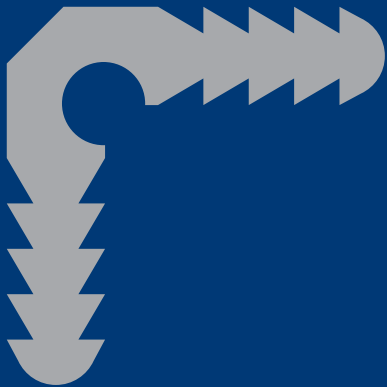

UA 1379

STAKING ANGLE

Fits 1385, 1386, 1387, 1649 - Blue

Fits 3592 - Red

Fits 4598 - White

kg/m 2.243 P 267

Cut to size

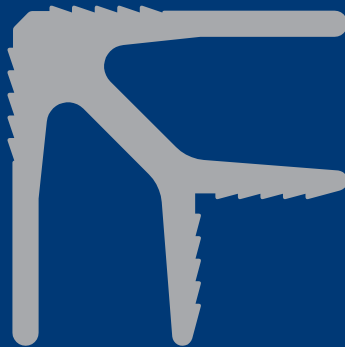

UA 5971

STAKING ANGLE

Fits 5655 - Orange

kg/m 4.524 P 496

Cut to size



CORNER STAKE - PLASTIC

Fits 6246

CODE: FLYFACS3PLGREY

or

CODE: CS3

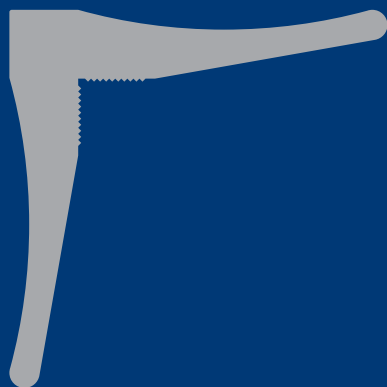

UA 1513

STAKING ANGLE

Fits 1054, 1389, 1610 - Green

kg/m 1.416 P 196

Cut to size

DOOR AND WINDOW ACCESSORIES

DESCRIPTION

TRUKEG9723 I I

**ROLLER/CORNER
FOR SECURITY
DOOR FRAME**



FLYDOORCLOS

DOOR CLOSER
WHITCO or DORIC
Bronze
Black
White

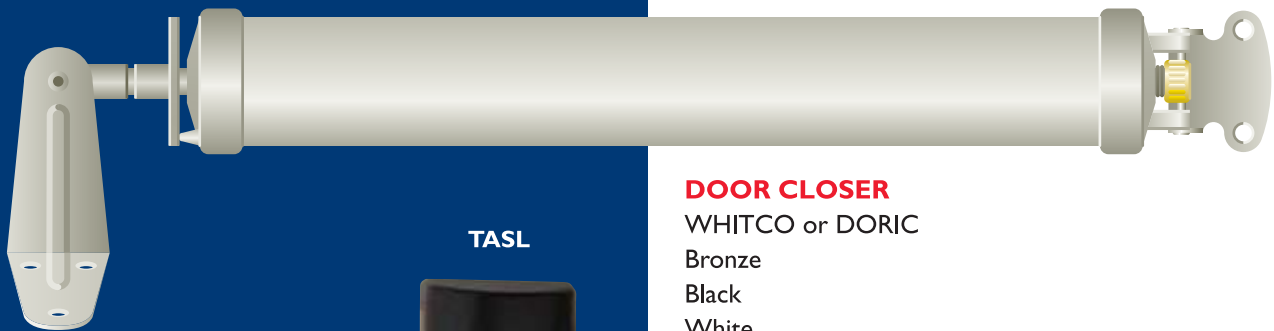

TASL

DOOR LOCKS



TASMAN MKIII - Black

Triple Lock Kits - Suits Tasman Lock

LIECHARDT SLIDING DOOR LOCK - Black

Anti Jemmy Kits available

Clear Polycarbonate Lock Protectors available

“D” Plates



TASLOCK PROTECT

(drawings not actual size)

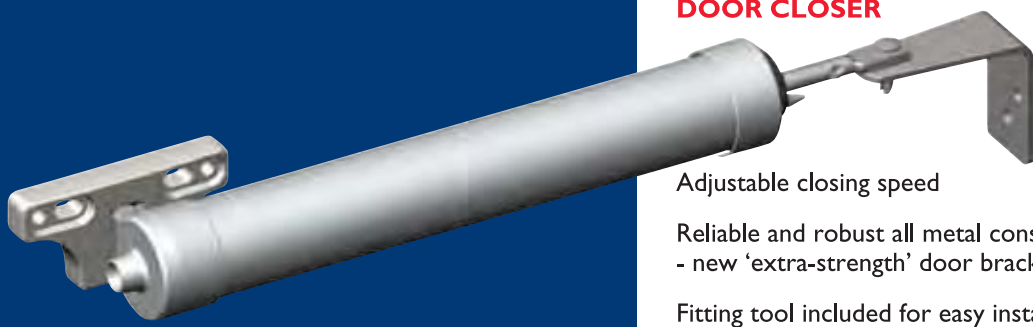

**AUSTRAL
DOOR CLOSER**

- Adjustable closing speed
- Reliable and robust all metal construction - new 'extra-strength' door bracket and end cap
- Fitting tool included for easy installation
- Available in a wide range of colours
- Australian design and manufacture
- Standard door closer for doors up to 18kg
- Heavy Duty door closer for doors up to 26kg



AUSTRAL ELEGANCE XC

- Interior snib lever for quick and convenient locking without the need for a key
- The jemmy resistant strike plate deforms under attack and remains engaged with the bolt for better security
- A notch in the latch bolt engages a profiled strike plate aperture to provide greater resistance to forced entry
- Multipoint kits are available for three point locking
- Optional 'Fat Pack' to install into doors 35mm-40mm thick
- Available in a wide range of colours
- Australian design and manufacture



AUSTRAL SD7

- Self-latching lock bolt engages automatically when the door is closed
- Anti-lift pin on catch plate engages the lock body to prevent the sliding door being lifted out of its tracks
- Interior snib locking feature.
- Multipoint kits are available for three point locking
- Optional 'Fat Pack' to install into doors 35mm-40mm thick
- Available in a wide range of colours
- Australian design and manufacture

(drawings not actual size)

SPLINE TOOLS

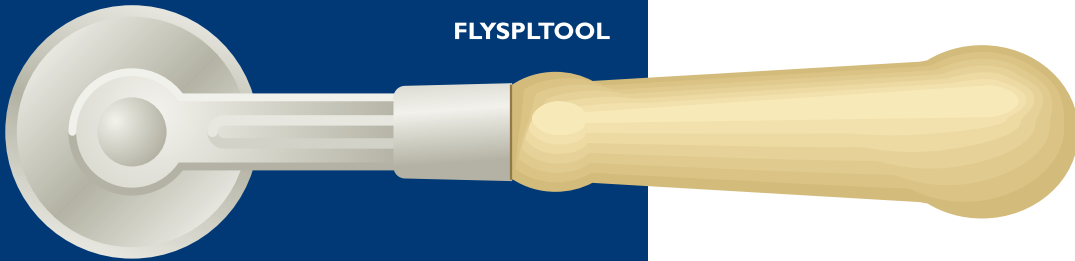

FLYSPLTOOL



KN7/SN6 COMBINATION

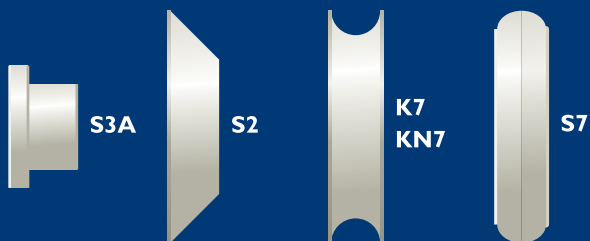

SPLINE WHEELS

- S3A** Steel Wheel
- S2** Steel Wheel
- K7** Steel Wheel
- KN7** Nylon Wheel
- S7** Steel Wheel

(drawings not actual size)

DOOR AND WINDOW ACCESSORIES

NEW ZEALAND'S LARGEST RANGE

Stainless Steel Screws

Rivets (coloured)

Drill Bits

Hinges

Hacksaw Blades

Screw Driver Bits

Sealants

Adhesives

Tools - De Walt, Makita

Air Tools

DESCRIPTION

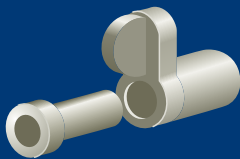
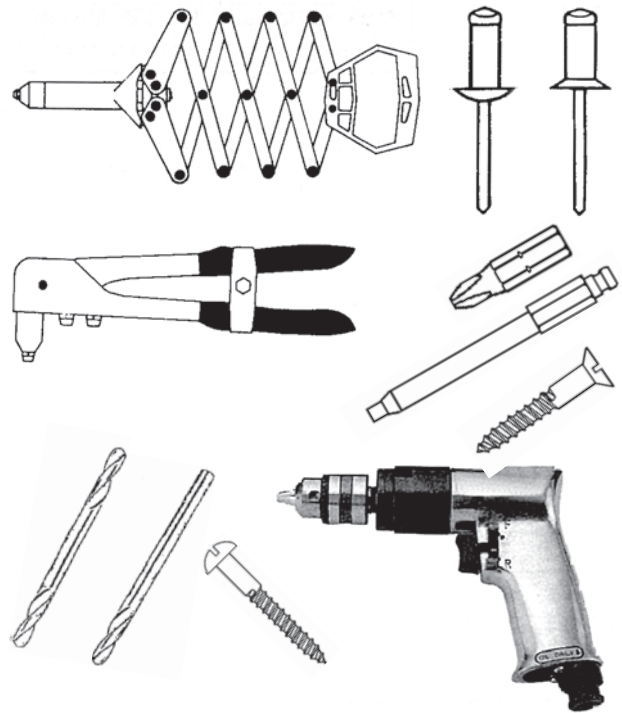

FLYTURNCATCH

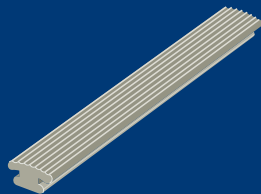

TURNCATCHES

Black

CLASHING STRIP

Vinyl

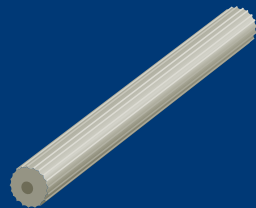

SPLINE

PVC RETAINING

SPLINE 5.0mm, 5.5mm, 6.0mm, 6.35mm

Grey
Black

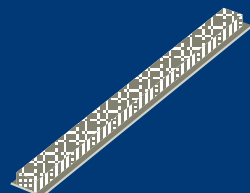

FLYWOOL

WOOL PILE

- PB 4875/3** 4.8 - 750B
- Grey 4.8 - 550B
- Black 4.8 - 850B
- 6.9 - 900B
- 6.9 - 700B
- 6.9 - 9525ADHBL Adhesive Backed



WOOL PILE

PR 13
Fits UA1349

(drawings not actual size)

DOOR AND WINDOW ACCESSORIES

DESCRIPTION



HSE

HINGES

SECURITY DOOR STEPPED HINGE
Black, White or Stainless



HINGE 65

65mm
Black or White



HINGE 38

38mm
Black or White

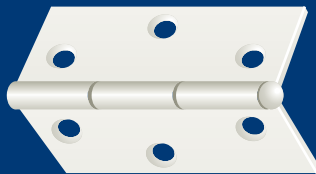

7903

SERIES 5000 HINGE



WHITPULL

WHITPULL HANDLE



SECUROWINSTAY

WINDOW STAY

Stainless Steel - Pair

PACKERS AVAILABLE



SECINTSTAY

INTERLOCK WINDOW STAY

(drawings not actual size)

DOOR AND WINDOW ACCESSORIES

DESCRIPTION



WHEEL CARRIAGES



KINGPINS



QUICK-RELEASE HINGES

**REMOVABLE WINDOW CATCH
FLYDORIC DS112**

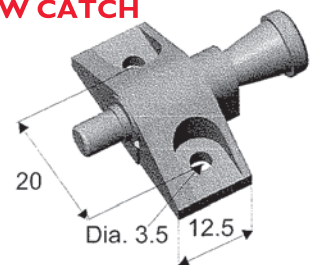

END STOP

(drawings not actual size)

DOOR AND WINDOW ACCESSORIES

DESCRIPTION



LOCK CYLINDERS
KEYED ALIKE
or
RANDOM KEYED



PUSH LOCK



WINDOW LOCKS



PATIO BOLT



SLIDE PUSH LOCK

(drawings not actual size)

EXPERIENCE

Ullrich Aluminium has over 20 years experience in Design, Extrusion and Distribution of Aluminium in Australia, New Zealand and the Pacific Islands. We pride ourselves on our excellent designs, technical advice and after sales service.



TESTING

Our new **Ullrich Mesh** stainless steel mesh and frame has been designed/ tested to AS5039/5041-2003 which includes impact, jemmy and knife shear tests.

FINISH

- Frames are available in a range of anodised or powdercoated colours.
- Screen is only available in black powdercoat.



FEATURES

- **Ullrich Mesh** is manufactured from high strength 316 stainless steel
- **Ullrich Mesh** mesh offers high security barrier to intruders
- **Ullrich Mesh** mesh allows free airflow
- **Ullrich Mesh** mesh has a higher corrosion resistance than other screens or meshes
- **Ullrich Mesh** mesh offers an unrestricted view



FRAMES

SECUS

COMPONENTS

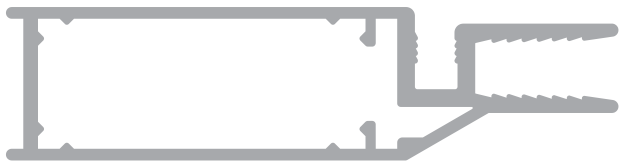

UA 7009
DOOR FRAME



UA 7008
SECURITY FRAME



US0003
9mm WINDOW FRAME



UA 7007
SECURITY JOINTER

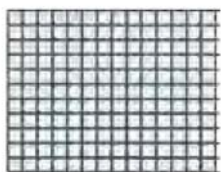

STAINLESS STEEL MESH
GRADE 316, 0.8mm

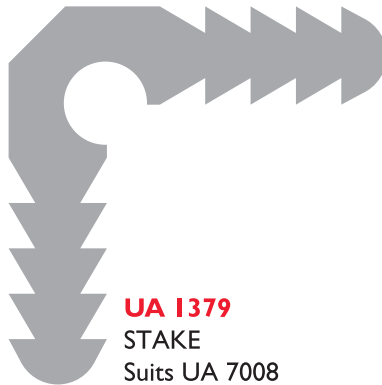

UA 1379
STAKE
Suits UA 7008

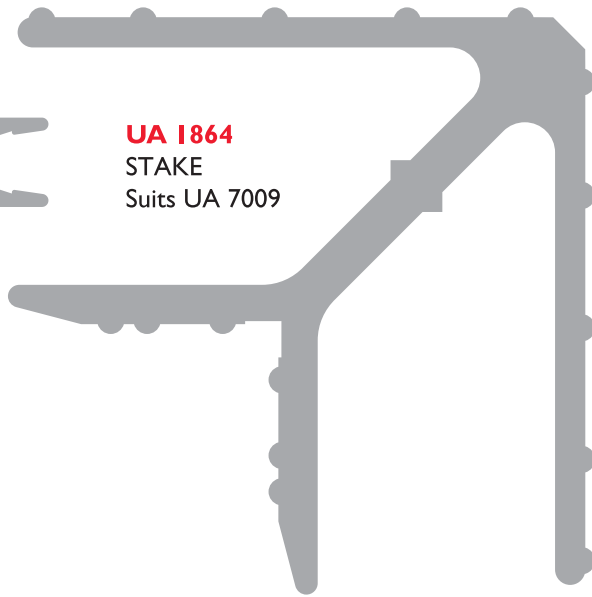

UA 1864
STAKE
Suits UA 7009



PCI11BK3
CHANNEL - WEDGE

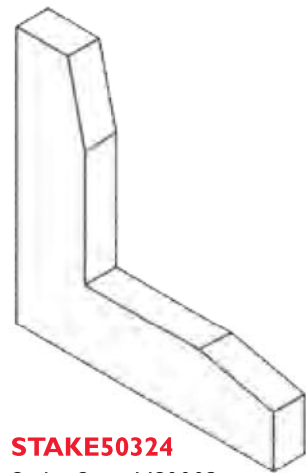

STAKE50324
Stake Suits US0003

Note: To comply with AS5039/5041-2003 the door must be manufactured as shown on drawing SEC0006

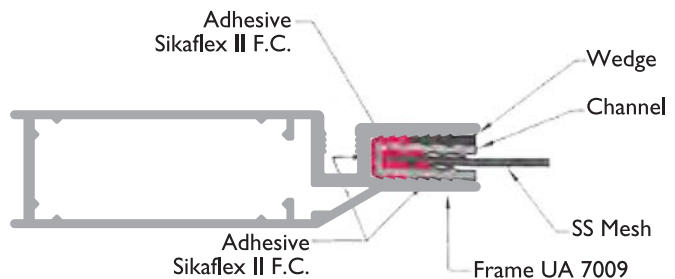
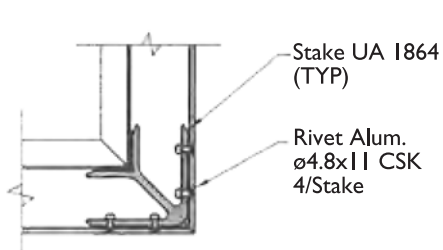



Phone for your nearest
ULLRICH ALUMINIUM SALES CENTRE

AUSTRALIA - 1300 650 075

NEW ZEALAND - 0800 500 338

- ALUMINIUM EXTRUSIONS
- ROLLED PRODUCTS
- FASTENINGS
- LADDERS
- SCAFFOLDS
- ULLTRACLAD CLADDING
- WINTEC WINDOWS & DOORS
- BUILDING PRODUCTS
- DECORATIVE METALS
- TEKNA MACHINERY
- ULLTIMATE SERIES WINDOWS & DOORS

Representative and franchised operations throughout the South Pacific

ULLRICH ALUMINIUM PTY LTD
 PO Box 246 Carole Park Queensland 4300
 20 Ron Boyle Crescent Carole Park Queensland Australia
 Tel +61 7 3718 1400 Fax +61 7 3271 1230
 ullrich@ullrich.com.au www.ullrich.com.au

ULLRICH ALUMINIUM CO LTD
 PO Box 98 843 Manukau City
 Auckland 2241 New Zealand
 Tel +64 9 262 6262 Fax +64 9 262 6265
 alkalum@uacl.co.nz www.ullrich.co.nz